

EN**INSTALLATION MANUAL**

EN Warning! Before proceeding with installation, read the Recommendations and Suggestions in the User Manual.

DE**INSTALLATIONSANLEITUNG**

DE Achtung! Lesen Sie vor Beginn der Installation die Sicherheitshinweise in der Bedienungsanleitung.

FR**MANUEL D'INSTALLATION**

FR Attention! Veuillez lire les consignes de sécurité que contient la Notice d'utilisation avant d'installer l'appareil.

NL**INSTALLATIE-INSTRUCTIES**

NL Waarschuwing! Lees de veiligheidsinformatie in de gebruikershandleiding voordat u met de installatie begint.

ES**MANUAL DE INSTALACIÓN**

ES ¡Atención! Antes de realizar la instalación, lea la información de seguridad del Manual del usuario.

PT**LIVRO DE INSTRUÇÕES PARA INSTALAÇÃO**

PT Atenção! Antes de continuar a instalação, leia as informações de segurança no Manual de Utilizador.

IT**LIBRETTO DI INSTALLAZIONE**

IT Attenzione! Prima di procedere all'installazione, leggere le Avvertenze e Suggestimenti contenute nel Libretto di Uso.

SV**INSTALLATIONSHANDBOK**

SV Varning! Läs säkerhetsanvisningarna i bruksanvisningen innan du fortsätter med installationen.

NO**INSTALLASJONSVEILEDNING**

NO Advarsel! Les sikkerhetsinformasjonene i bruksanvisningen før du begynner installasjonen.

FI**ASENNUSOHJEET**

FI Varoitus! Ennen kuin aloitat asennuksen, lue käyttöohjeen sisältämät turvallisuusohjeet.

DA**INSTALLATIONSVEJLEDNING**

DA Vigtigt! Læs brugsanvisningens instruktioner vedrørende sikkerhed, før installationen påbegyndes.

RU**РУКОВОДСТВО ПО УСТАНОВКЕ**

RU Внимание! Перед тем как приступить к установке, прочтите информацию по технике безопасности в руководстве пользователя.

ET**PAIGALDUSJUHEND**

ET Hoiatus! Enne paigaldamist lugege läbi kasutusjuhendis olevad ohutusjuhised.

LV**UZSTĀDĪŠANAS ROKASGRĀMATA**

LV Brīdinājums! Pirms turpināt uzstādīšanu, izlasiet lietotāja rokasgrāmatā ietverto drošības informāciju.

LT**ĮRENGIMO VADOVAS**

LT Įspėjimas! Prieš montuodami perskaitykite saugos informaciją naudojimo instrukcijoje.

UK**ІНСТРУКЦІЯ ЗІ ВСТАНОВЛЕННЯ**

UK Увага! Перед початком встановлення прочитайте інформацію щодо безпеки у Посібнику користувача.

HU**ÜZEMBE HELYEZÉSI ÚTMUTATÓ**

HU Vigyázat! Mielőtt továbblépne az üzembe helyezéssel, olvassa el a biztonsági információkat a felhasználói kézikönyvben.



CS NÁVOD K MONTÁŽI
CS Upozornění! Před začátkem instalace si přečtěte bezpečnostní informace v návodu k použití.

SK INŠTALAČNÁ PRÍRUČKA
SK Upozornenie! Pred inštaláciou si prečítajte bezpečnostné pokyny v návode na používanie.

RO MANUAL DE INSTALARE
RO Atenție! Înainte de a trece la instalare, citiți informațiile privind siguranța din Manualul Utilizatorului.

PL INSTRUKCJA INSTALACJI
PL Ostrzeżenie! Przed rozpoczęciem instalacji należy przeczytać informacje dotyczące bezpieczeństwa podane w Instrukcji obsługi.

HR KNJIŽICE S UPUTAMA
HR Upozorenje! Prije instalacije pročitajte sigurnosne informacije u Uputama za uporabu.

SL NAVODILO ZA NAMESTITEV
SL Opozorilo! Pred nadaljevanjem z namestitvijo preberite varnostna navodila v navodilih za uporabo.

EL ΟΔΗΓΙΕΣ ΕΓΚΑΤΑΣΤΑΣΗΣ
EL Προειδοποίηση! Πριν συνεχίσετε με την εγκατάσταση, διαβάστε τις πληροφορίες ασφάλειας στο εγχειρίδιο χρήστη.

TR MONTAJ KİTAPÇIĞI
TR Uyarı! Montaj işleminde başlamadan önce, kullanma kılavuzundaki güvenlik bilgilerinin okuyunuz.

BG РЪКОВОДСТВО ЗА МОНТАЖ
BG Внимание! Преди да пристъпите към инсталирането, прочетете информацията за безопасност в Ръководството за потребителя.

KK ОРНАТУ НҮСҚАУЛЫҒЫ
KK Ескерту! Орнату алдында, пайдаланушы нұсқаулығындағы қауіпсіздік туралы ақпаратты оқыңыз.

MK УПАТСТВО ЗА МОНТАЖА
MK Предупредување! Пред да започнете со монтажа, прочитајте ги информациите за безбедност во Упатството за корисник.

SQ UDHËZUES PËR INSTALIMIN
SQ Paralajmërim! Përpara se të kryeni instalimin, lexoni të dhënat e sigurisë në Manualin e Përdorimit.

SR УПУТСТВО ЗА ИНСТАЛИРАЊЕ
SR Упозорење! Пре него што приступите инсталирању уређаја, прочитајте информације о безбедности у Упутству за употребу.

AR كِتَاب التَّرْكِيْب
AR تنبيه! قبل البدء بالتَّركيب، يرجى قراءة تعليمات السلامة الموجودة في كتيب تعليمات الاستعمال.



± 35 Kg
(900 mm)

± 40 Kg
(1200 mm)

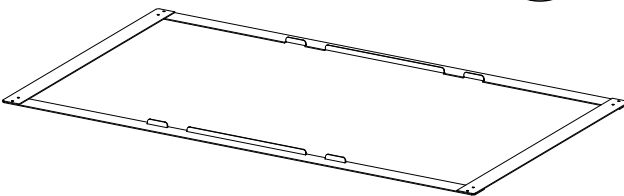
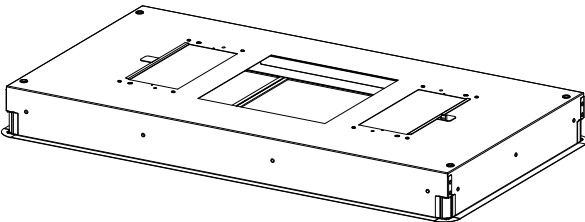
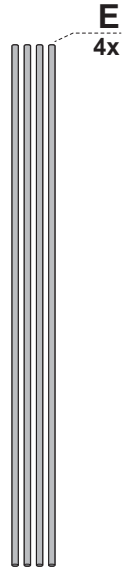
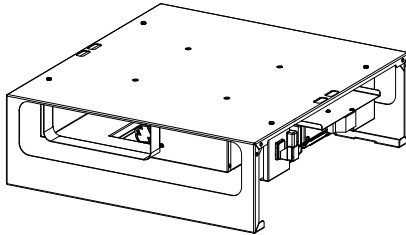
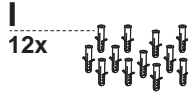
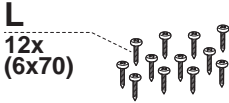
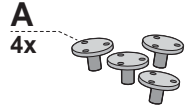
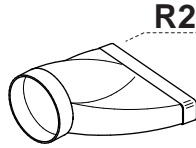
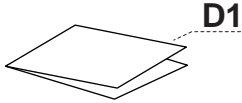
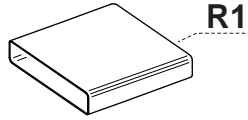

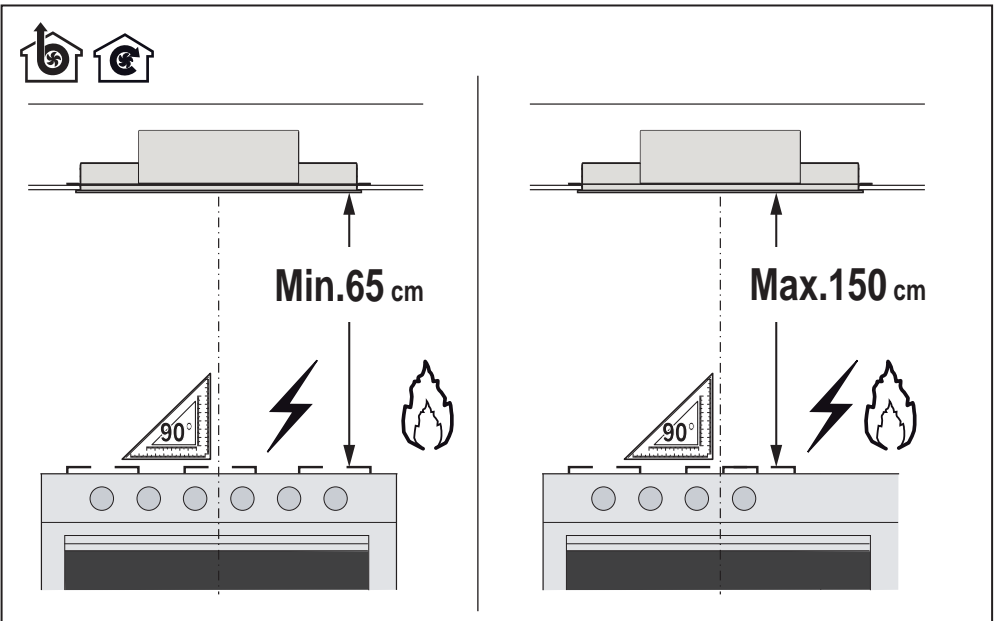
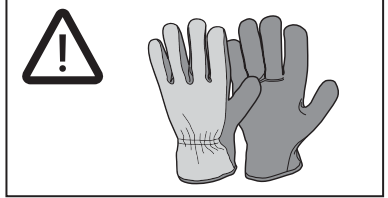
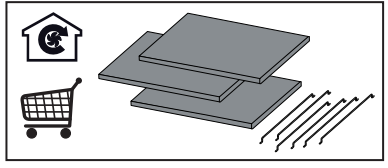
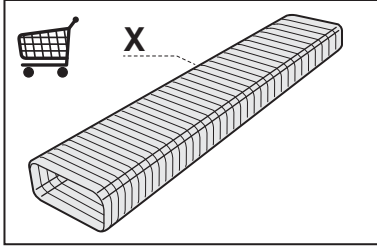
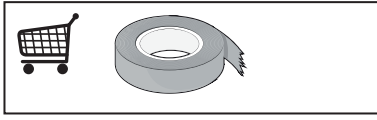
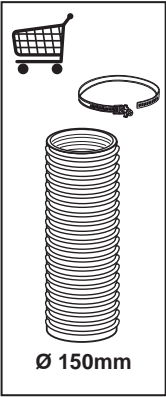
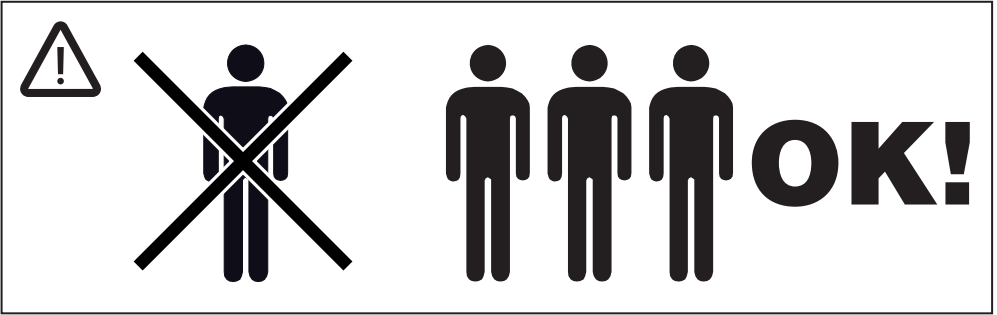

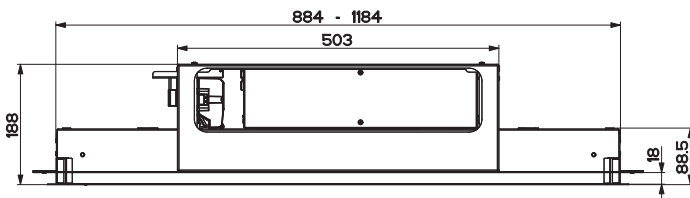
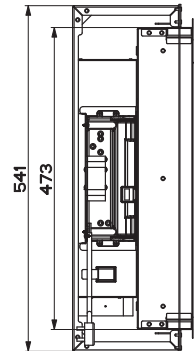
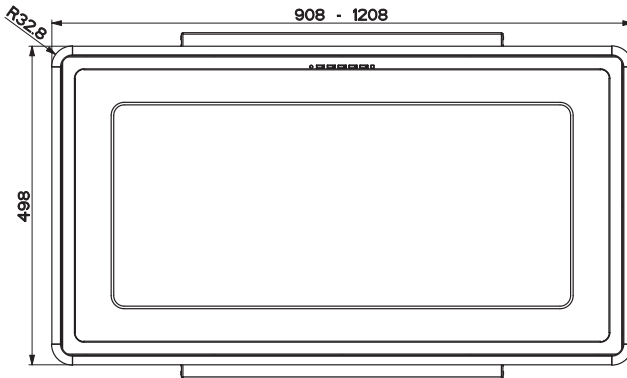
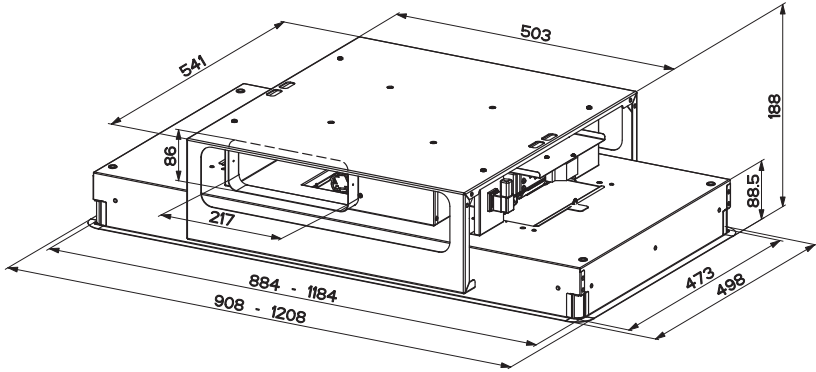

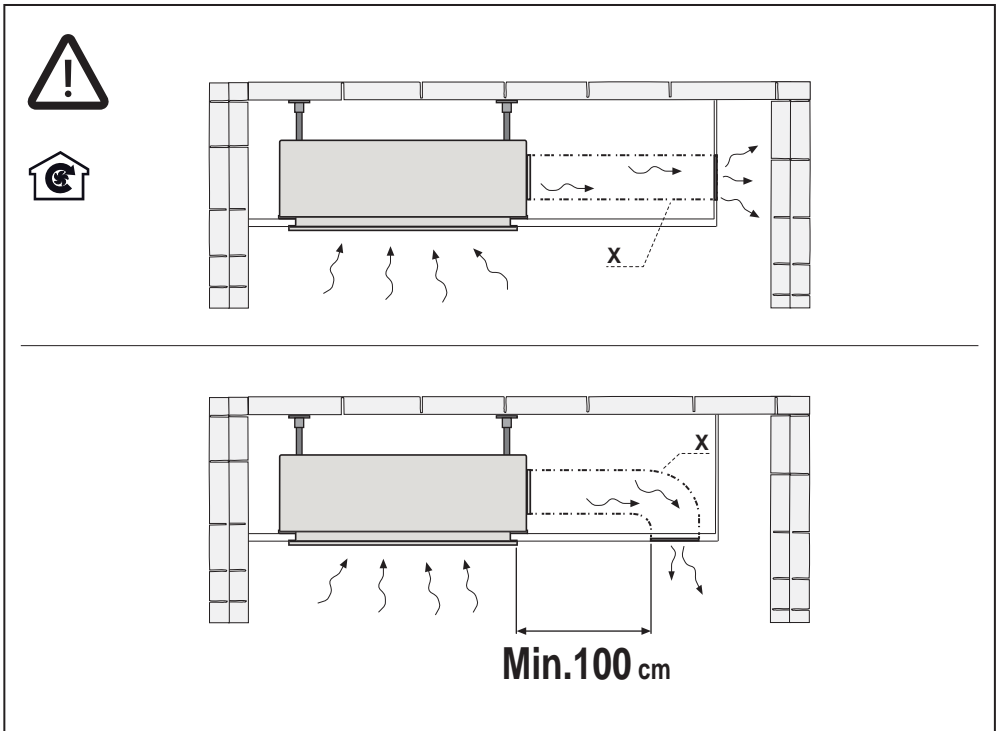
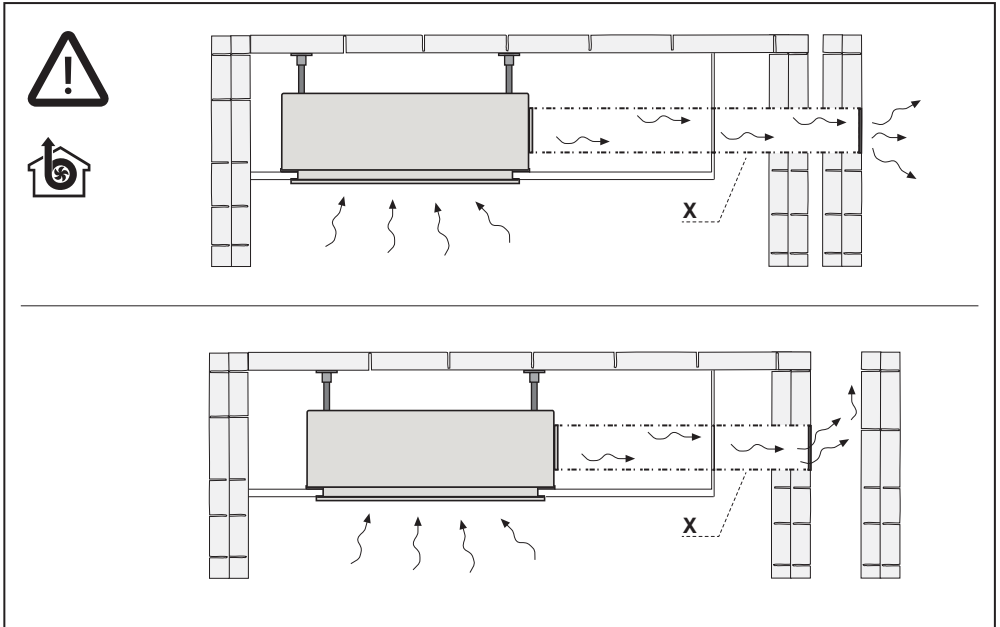

1

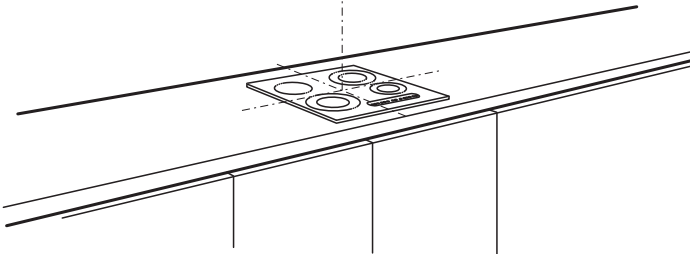
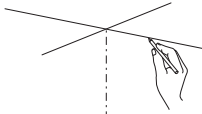
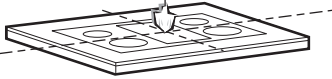
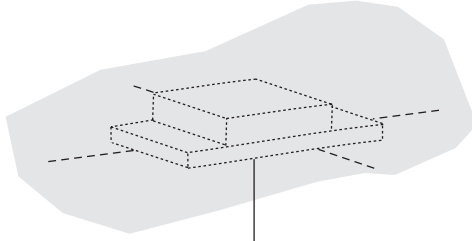

2

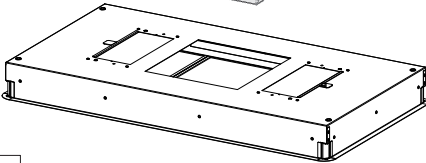
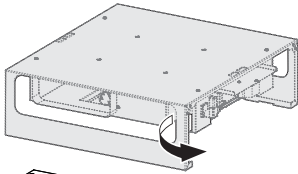
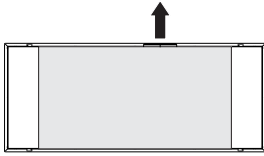

1

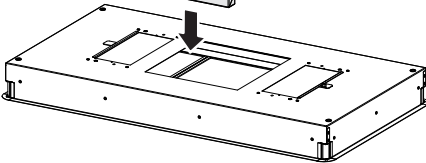
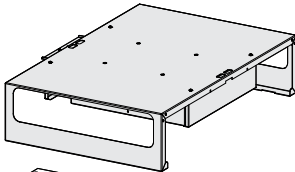

2

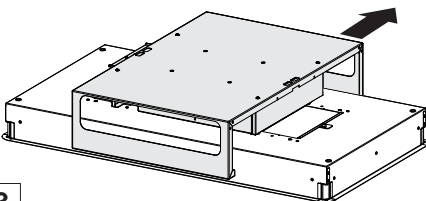

3

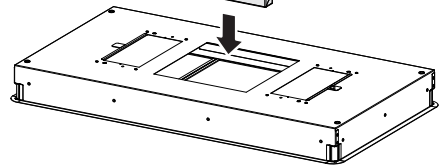
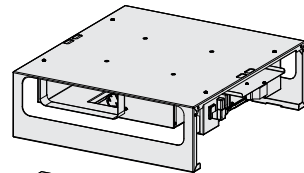
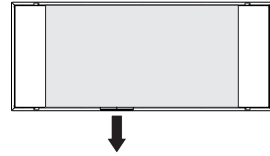

1

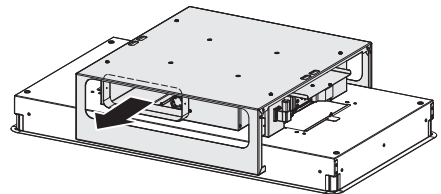

2

3

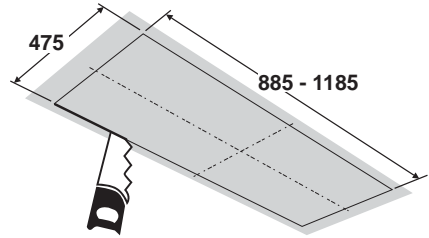
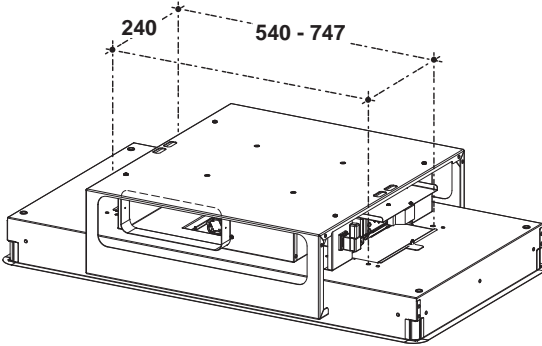

4

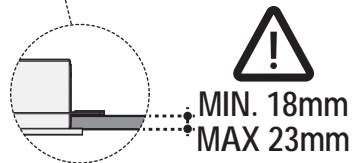
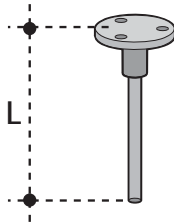
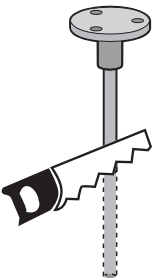
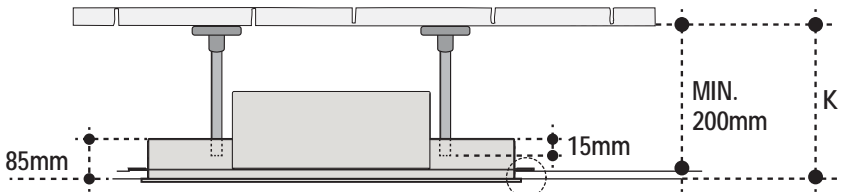

$$L = K - 85 + 15\text{mm}$$

5

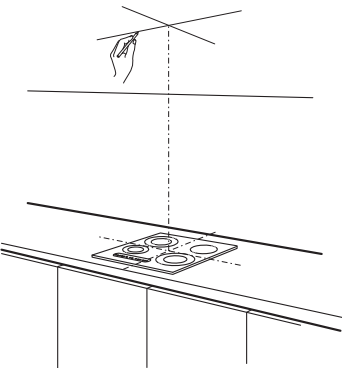
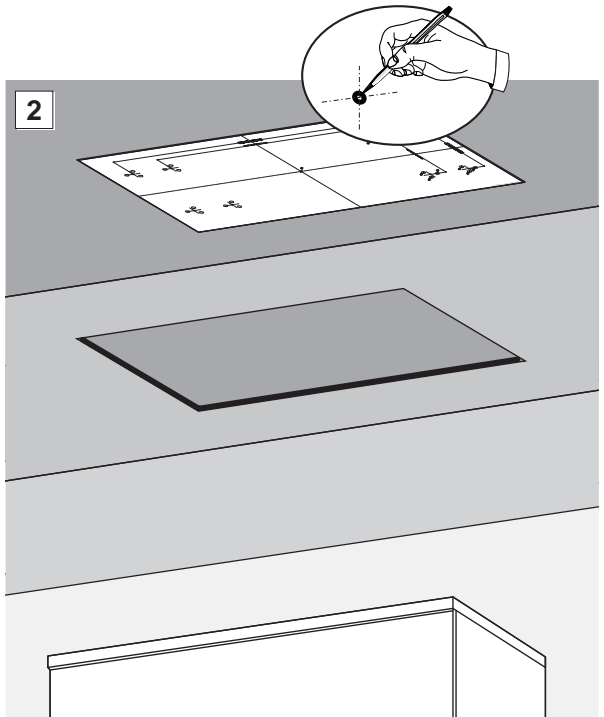
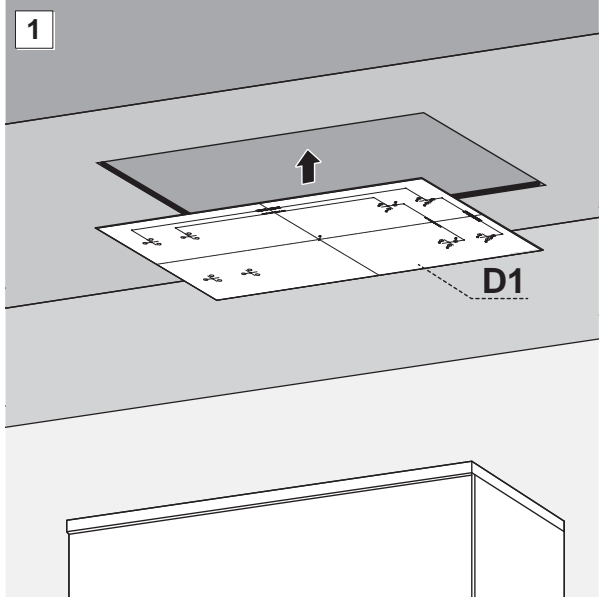

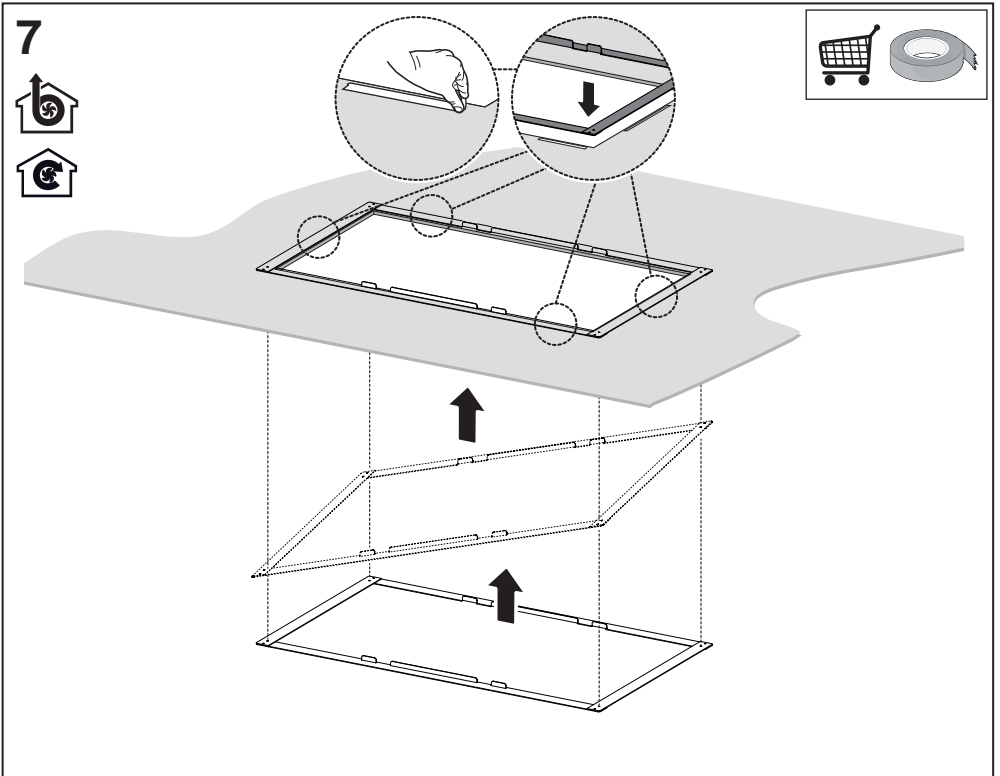
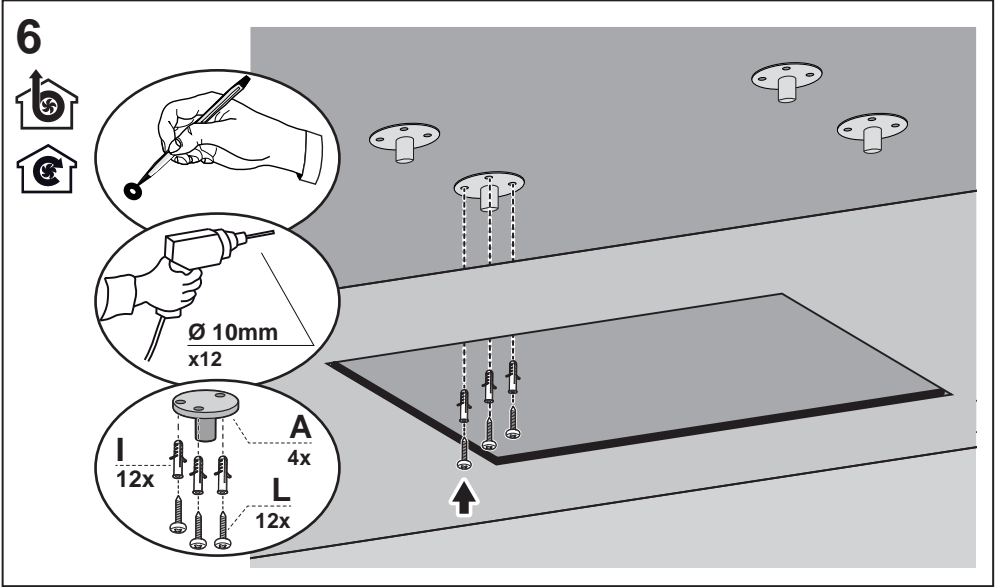

8

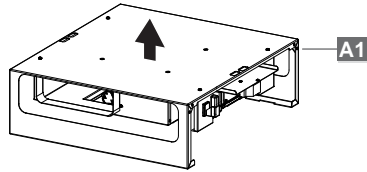
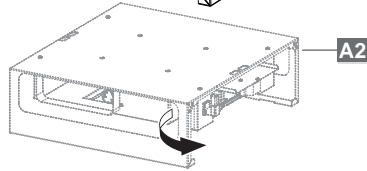
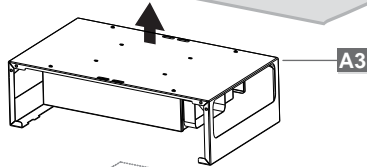
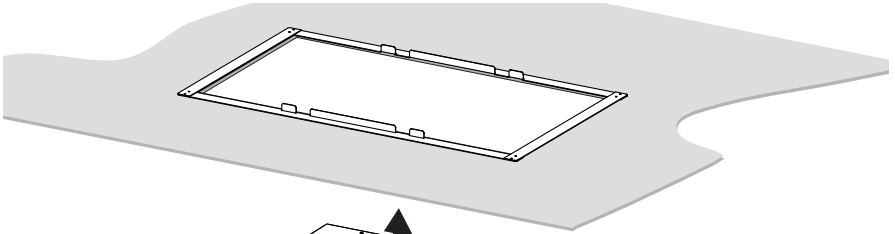

A

B

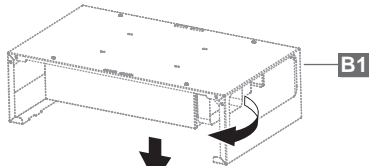

11,8Kg

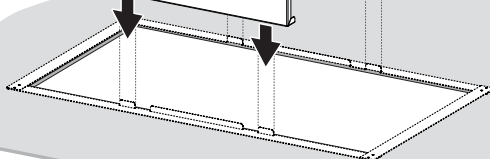
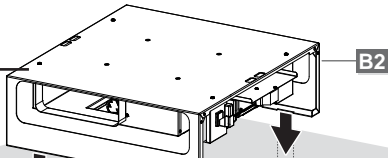

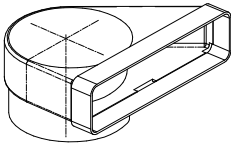
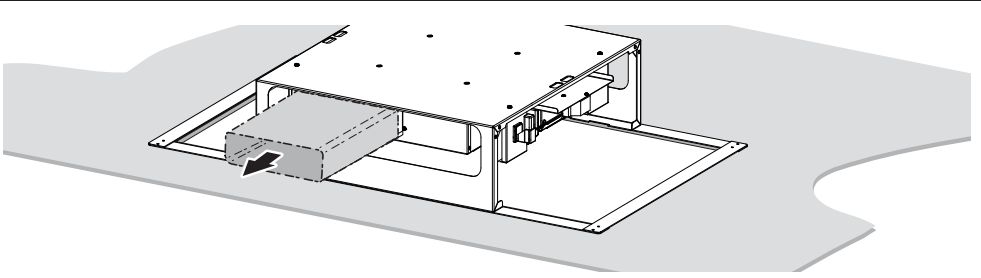

112.0459.451

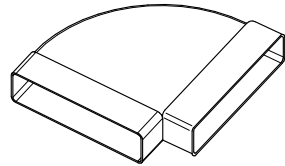

112.0459.455

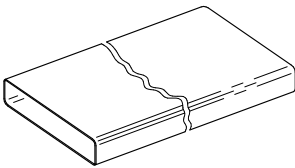

112.0459.427

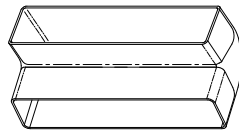

112.0459.453

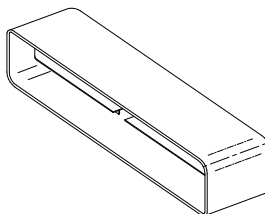

112.0459.428

9

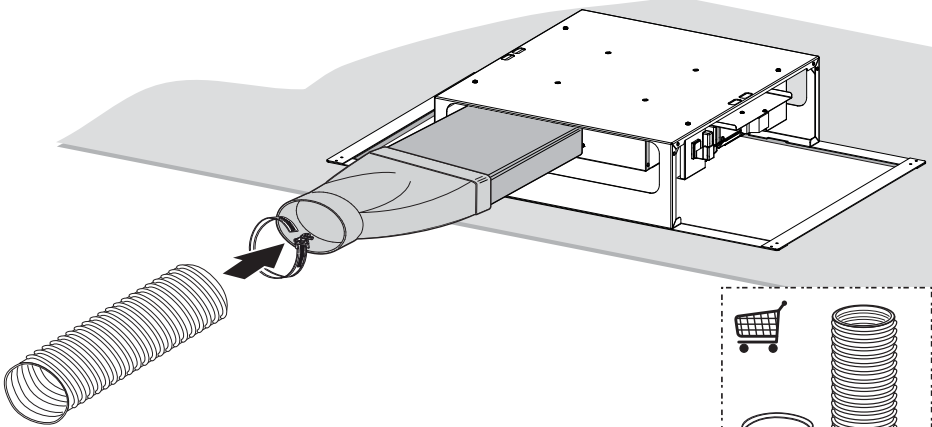
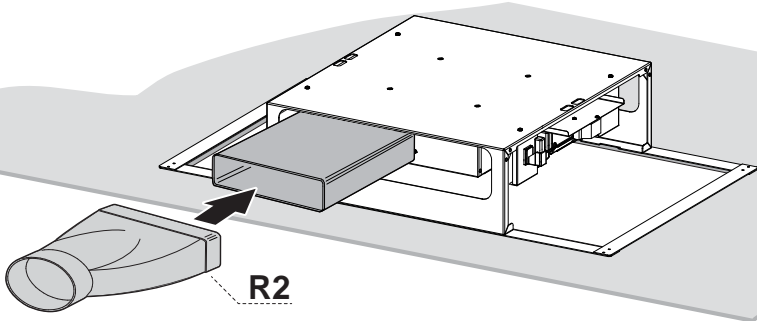
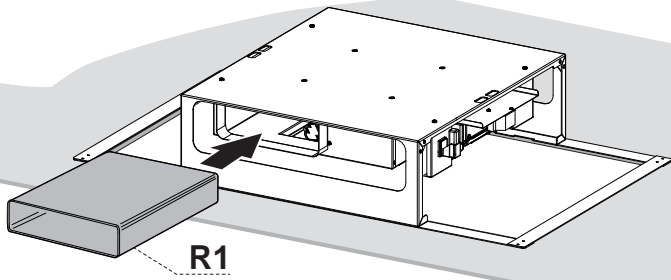

Ø 150mm

10

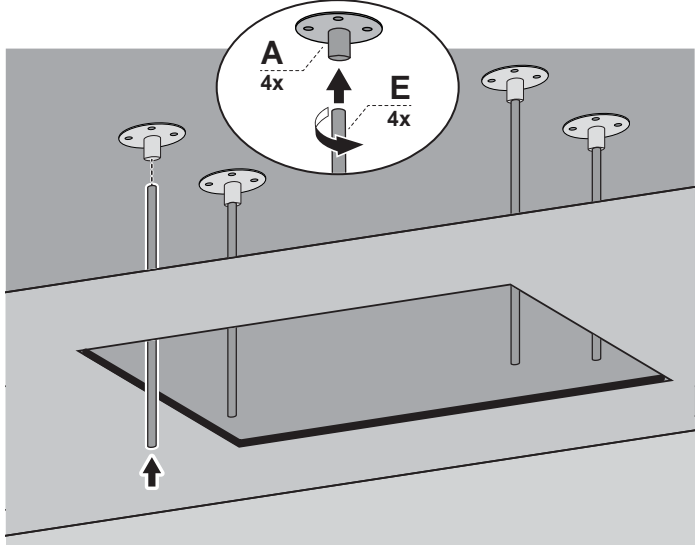

11

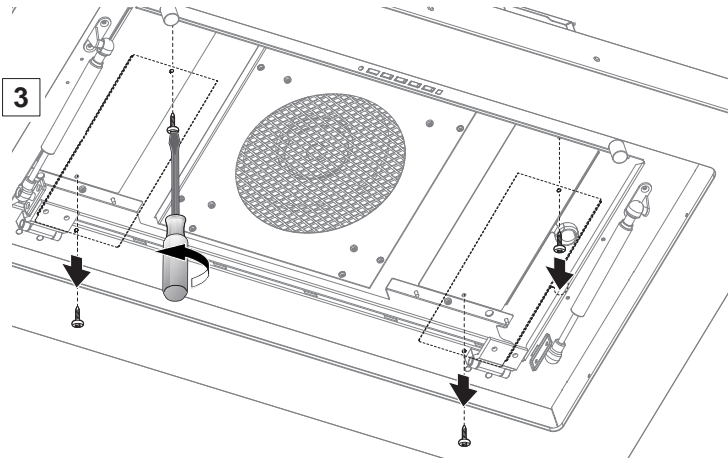
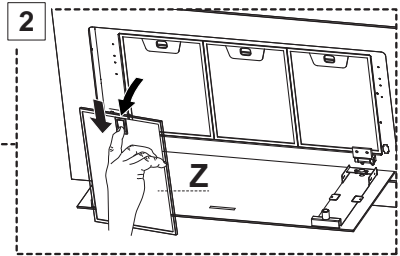
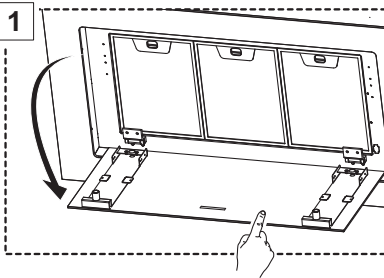

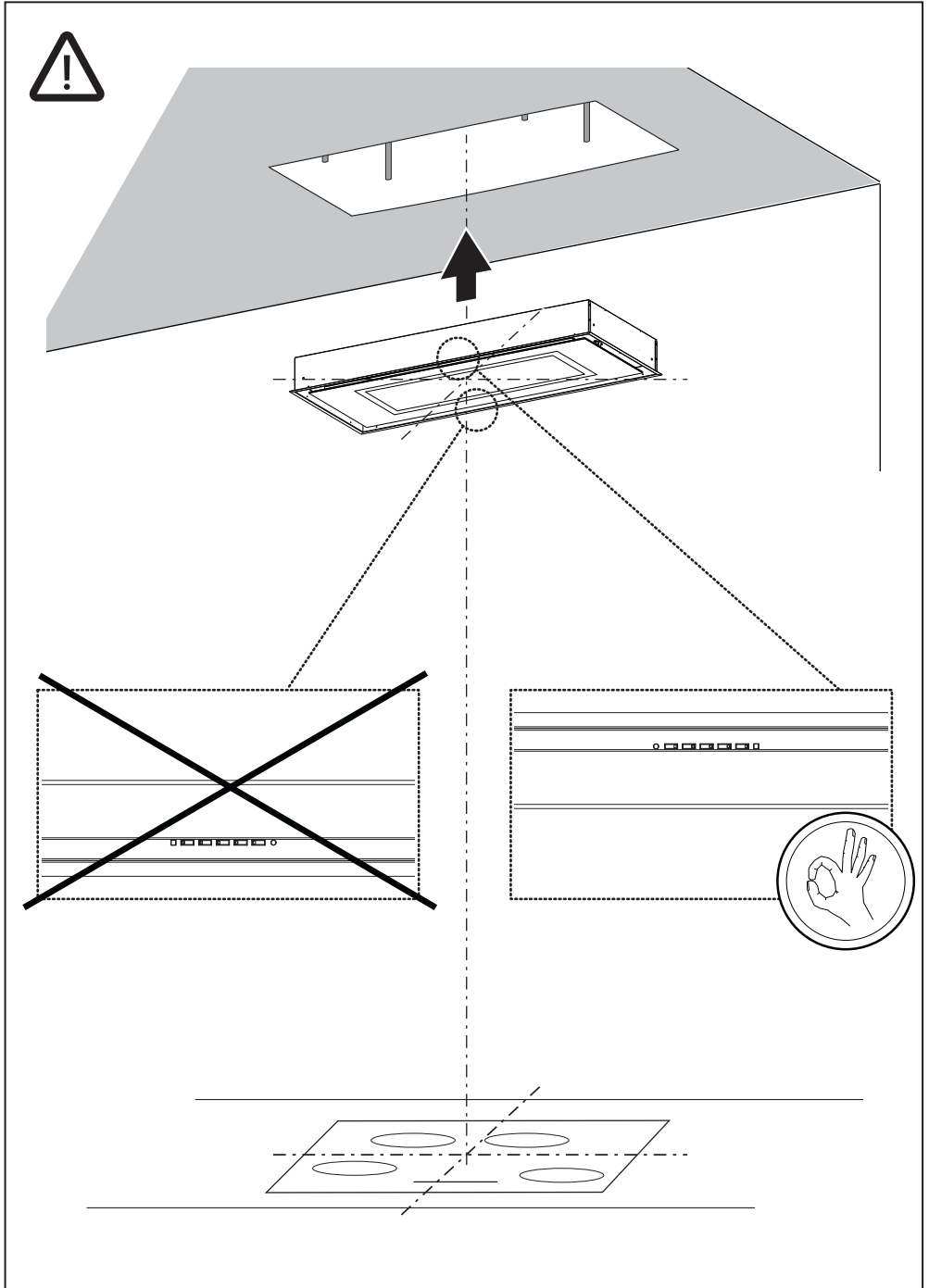

12

